

Varenummer: 201138007
Beskrivelse: E+G Fingregreb
GN 7336-42-M8-15-ST

Mål

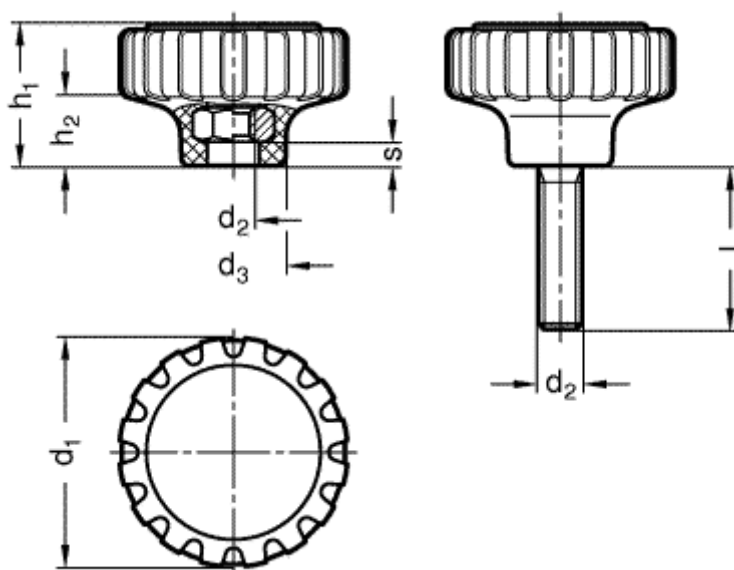

$d_1 = 42$
 $d_2 = M 8$
 $d_3 = 19$
 $h_1 = 25$
 $h_2 = 13$
 $l = 15$
 $s = 5$